



FLECK 5600
SERVICE MANUAL



TABLE OF CONTENTS

JOB SPECIFICATION SHEET	2
INSTALLATION.....	3
START-UP INSTRUCTIONS.....	4
MODEL 5600 INSTALLATION AND START-UP PROCEDURES.....	4
MODEL 5600 BACKWASH FILTER INSTALLATION AND START-UP PROCEDURES.....	5
MODEL 5600 INSTALLATION AND START-UP PROCEDURES.....	6
WATER CONDITIONER FLOW DIAGRAMS.....	7
MODEL 5600 CONTROL VALVE DRIVE ASSEMBLY.....	10
5600 ELECTROMECHANICAL	16
5600 VALVE ACCESSORIES	17
5600 VALVE ASSEMBLIES	18
SERVICE INSTRUCTIONS	21
TROUBLESHOOTING.....	24
GENERAL SERVICE HINTS FOR METER CONTROL.....	25
MODEL 5600SF TROUBLESHOOTING	25

JOB SPECIFICATION SHEET

Job Number: _____
Model Number: _____
Water Hardness: _____ ppm or gpg
Capacity Per Unit: _____
Mineral Tank Size: _____ Diameter: _____ Height: _____
Salt Setting per Regeneration: _____

1. Type of Timer:

- A. Time Clock
- B. Meter Initiated

2. Downflow: Upflow Upflow Variable

3. Meter Size:

- A. 3/4-inch Turbine
- B. 3/4-inch Paddle Wheel
- C. Electronic ____ Pulse Count ____ Meter Size _____

4. System Type:

- A. System #4: 1 Tank, 1 Meter, Immediate, or Delayed Regeneration
- B. System #4: Time Clock

5. Timer Program Settings:

- A. Backwash: _____ Minutes
- B. Brine and Slow Rinse: _____ Minutes
- C. Rapid Rinse: _____ Minutes
- D. Brine Tank Refill: _____ Minutes
- E. Pause Time: _____ Minutes
- F. Second Backwash: _____ Minutes

6. Drain Line Flow Control: gpm

7. Brine Line Flow Controller: gpm

8. Injector Size#:

CALIFORNIA PROPOSITION 65 WARNING

⚠ WARNING: This product contains chemicals known to the State of California to cause cancer or birth defects or other reproductive harm.

INSTALLATION

Water Pressure

A minimum of 25 psi (1.7 bar) of water pressure is required for regeneration valve to operate effectively.

Electrical Facilities

An uninterrupted alternating current (A/C) supply is required. Please make sure voltage supply is compatible with unit before installation.

NOTE: Other voltages are available. Please make sure your voltage supply is compatible with your unit before installation.

Existing Plumbing

Condition of existing plumbing should be free from lime and iron buildup. Piping that is built up heavily with lime and/or iron should be replaced. If piping is clogged with iron, a separate iron filter unit should be installed ahead of the water softener.

Location Of Softener And Drain

The softener should be located close to a drain to prevent air breaks and back flow.

Bypass Valves

Always provide for the installation of a bypass valve if unit is not equipped with one.

CAUTION Water pressure is not to exceed 125 psi (8.6 bar), water temperature is not to exceed 110°F (43°C), and the unit cannot be subjected to freezing conditions.

Installation Instructions

1. Place the softener tank where you want to install the unit making sure the unit is level and on a firm base.
2. During cold weather, the installer should warm the valve to room temperature before operating.
3. All plumbing should be done in accordance with local plumbing codes. The pipe size for residential drain line should be a minimum of 1/2 inch (13 mm). Backwash flow rates in excess of 7 gpm (26.5 Lpm) or length in excess of 20 feet (6 m) require 3/4 inch (19 mm) drain line. Commercial drain lines should be the same size as the drain line flow control.
4. Refer to the dimensional drawing for cutting height of the distributor tube. If there is no dimensional drawing, cut the distributor tube flush with the top of the tank.
5. Lubricate the distributor o-ring seal and tank o-ring seal. Place the main control valve on tank.

NOTE: Only use silicone lubricant.

6. Solder joints near the drain must be done prior to connecting the Drain Line Flow Control fitting (DLFC). Leave at least 6 inches (15 cm) between the DLFC and solder joints when soldering pipes that are connected on the DLFC. Failure to do this could cause interior damage to the DLFC.
7. Plumber tape is the only sealant to be used on the drain fitting. The drain from twin tank units may be run through a common line.
8. Make sure that the floor is clean beneath the salt storage tank and that it is level.
9. Place approximately 1 inch (25 mm) of water above the grid plate. If a grid is not utilized, fill to the top of the air

check (Figure 1) in the salt tank. Do not add salt to the brine tank at this time.

10. On units with a by-pass, place in bypass position. Turn on the main water supply. Open a cold soft water tap nearby and let run a few minutes or until the system is free from foreign material (usually solder) that may have resulted from the installation. Once clean, close the water tap.
11. Slowly place the by-pass in service position and let water flow into the mineral tank. When water flow stops, slowly open a cold water tap nearby and let run until the air is purged from the unit.
12. Plug unit into an electrical outlet.

NOTE: All electrical connections must be connected according to local codes. Be certain the outlet is uninterrupted.

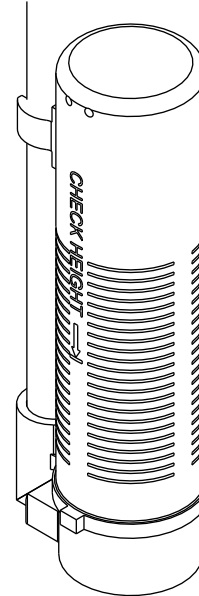

60002 Rev E

Figure 1 Residential Air Check Valve

START-UP INSTRUCTIONS

The water softener should be installed with the inlet, outlet, and drain connections made in accordance with the manufacturer's recommendations, and to meet applicable plumbing codes.

1. Turn the manual regeneration knob slowly in a clockwise direction until the program micro switch lifts on top of the first set of pins. Allow the drive motor to move the piston to the first regeneration step and stop. Each time the program switch position changes, the valve will advance to the next regeneration step. Always allow the motor to stop before moving to the next set of pins or spaces.
2. Position the valve to backwash. Ensure the drain line flow remains steady for 10 minutes or until the water runs clear (see above).
3. Position the valve to the brine / slow rinse position. Ensure the unit is drawing water from the brine tank (this step may need to be repeated).
4. Position the valve to the rapid rinse position. Check the drain line flow, and run for 5 minutes or until the water runs clear.
5. Position the valve to the start of the brine tank fill cycle. Ensure water goes into the brine tank at the desired rate. The brine valve drive cam will hold the valve in this position to fill the brine tank for the first regeneration.
6. Put salt in the brine tank.

NOTE: Do not use granulated or rock salt.

MODEL 5600 INSTALLATION AND START-UP PROCEDURES

NOTE: Install the water softener with the inlet, outlet, and drain connections made according to manufacturer's recommendations and to meet applicable plumbing codes.

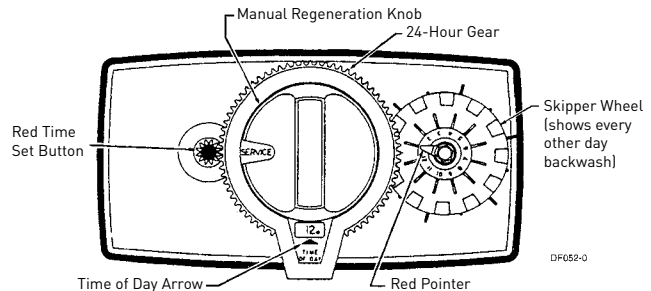

1. Manually index the softener control into the In Service position and let water flow into the resin tank. When the water flow stops, open a softened water tap until all air is released from the lines. Then close tap.

NOTE: Manually dial the various regeneration positions by turning the knob on the front of the control until the indicator shows that the softener is in the desired position.

2. Manually index the control to the Backwash position and allow water to flow at the drain for 3 or 4 minutes.
3. Remove back cover plate.
4. Make sure that the salt dosage is set as recommended by the manufacturer. If necessary, set salt according to the setting instruction sheet. Manually index the control to the Brine Fill position and allow the brine tank to fill to the top of the air check.
5. Manually index the control to the Brine Draw position and allow the control to draw water from the brine tank until it stops.
6. Plug in the electrical cord and look in the sight hole in the back of the motor to see that it is running. Set the days that regeneration is to occur by sliding tabs on skipper wheel outward to expose trip fingers.
 - Each tab is one day.
 - Finger at red pointer is tonight.
 - Moving clockwise from red pointer, extend or retract fingers to obtain the desired generation schedule.
7. Manually advance the control to the beginning of the Brine Fill position and allow the control to return to the In Service position automatically.
8. Fill the brine tank with salt.
9. Replace back cover on the control.
10. Make sure that any bypass valving is left in the normal In Service position.

MODEL 5600 BACKWASH FILTER INSTALLATION AND START-UP PROCEDURES

NOTE: Install the water softener with the inlet, outlet, and drain connections made according to manufacturer's recommendations and to meet applicable plumbing codes.

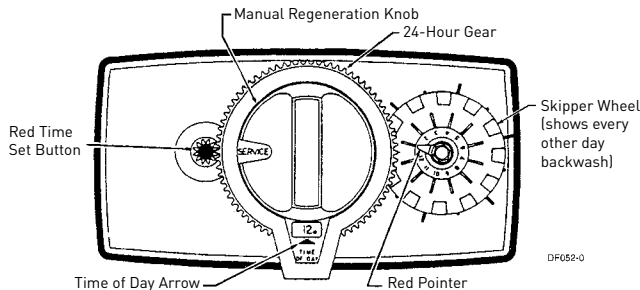

Before plugging in the Unit

1. Open a treated water tap down stream of the filter.
2. Manually index the filter to the In Service position and allow the mineral tank to fill by slowly opening the main water supply valve. Any bypass should be in the In Service position.

NOTE: The water flowing from the downstream tap is cloudy and/or contains media fines as well as air. Allow the water to run until it appears clean and free of air.

3. When a steady clean flow appears at the tap, close the tap and the main water supply valve and allow the filter media bed to settle for 15–20 minutes.
4. Manually index the filter to the Backwash position.
5. To prevent a sudden surge of water and air, partially open the main water supply valve so that the flow at the drain of the filter is approximately 1 gpm (3.7 Lpm). The water at the drain is cloudy again and/or contains media fines as well as air. Allow water to flow at the drain until it appears clean and free of air.
6. Continue to open the water supply valve until it is completely open. Allow water to flow at the drain until all media fines are washed out of the filter.
7. Manually index the filter to the In Service position, and again open the downstream tap. Check to be sure that the water flows clear. If necessary, allow water to flow until all media fines are gone. If the tap is equipped with an aerator check that is not plugged with media fines and pipe scale.
8. Plug in the electrical cord and look in the sight hole on the back of the timer motor to ensure that it is running. Set the days backwashing is to occur by sliding tabs on the skipper wheel outward to expose trip fingers. Each tab is one day. Finger at red pointer is tonight. Moving clockwise from red pointer, extend or retract fingers to obtain the desired backwash schedule.
9. Set time of day by pushing red button and spin the 24-hour gear until the present time of day is visible above the time of day arrow.

Cycle Times and Flow Diagrams

1. In Service position. See page 7.
2. Preliminary Rinse position.
 - See page 7 with standard piston (white end plug) or filter piston (black end plug).
 - Eliminated with low water piston (gray end plug).
3. Backwash position.
 - See page 7 with standard piston.
 - 15 minutes with filter piston.
 - 7 minutes with low water piston.
4. Brine Rinse position.
 - Eliminated, resulting in a 50 minute pause, no water flows during this time.
5. Slow Rinse position.
 - Eliminated, resulting in a 50 minute pause, no water flows during this time.
6. Second Backwash position.
 - See page 8 with standard piston.
 - 15 minutes with filter piston.
 - 7 minutes with low water piston.
7. Settling Rinse position.
 - See page 8 with standard or filter piston.
 - Eliminate with low water piston.
8. Brine Tank Refill position.
 - Eliminated, filter is back in service at this time.

MODEL 5600 INSTALLATION AND START-UP PROCEDURES

NOTE: Install the water softener with the inlet, outlet, and drain connections made according to manufacturer's recommendations and to meet applicable plumbing codes.

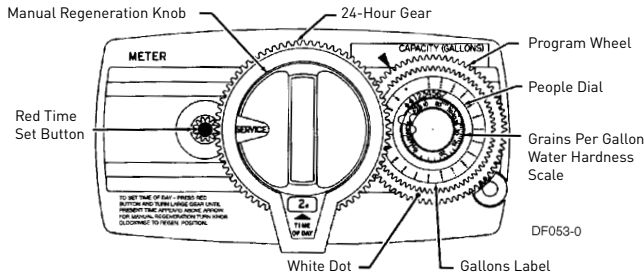

Before plugging in the Unit

1. Manually index the softener control to the In Service position and let water flow into the resin tank. When the water flow stops, open a softened water tap until all air is released from the lines. Then close tap.
2. The various regeneration positions may be dialed manually by turning the knob on the front of the control until the indicator shows that the softener is in the desired position.
3. Set water usage program wheel using any one of the following procedures:
Typical Residential Application
 To program, just set the time, set the hardness and it automatically monitors system needs and regenerates only when necessary. To set time of day press red time set button and turn 24-hour gear until present time of day is at "time of day." Set program wheel by lifting the "people" dial and rotating it so that the number of people in the household is aligned with the household grains per gallon water hardness. Release the dial and check for firm engagement at setting. This method provides reserve capacity based on 75 gallons per person.
Optional Programming Procedures
 Calculate the gallon capacity of the system, subtract the necessary reserve requirement and set the gallons available at the small white dot on program wheel gear. Note, drawing shows 850 gallon setting. The capacity (gallons) arrow denotes remaining gallons exclusive of fixed reserve.
4. Rotate program wheel counterclockwise until it stops at Regeneration position.
5. Manually index the control to the Backwash position and allow water to flow at the drain for 3 or 4 minutes.
6. Remove back cover plate.
7. Make sure than the salt dosage is set as recommended by the manufacturer. Manually index the control to the Brine Fill position and allow the brine tank to fill to the top of the air check.
8. Manually index the control to the Brine Rinse position and

allow the control to draw water from the brine tank until it stops. Plug in the electrical cord and look in the sight hole in the back of the monitor to see that it is running.

9. Manually advance the control to the beginning of the Brine Fill position and allow the control to return to the In Service position automatically.
10. Fill the brine tank with salt.
11. Replace back cover on the control. Be sure cable is not pinched between cover and housing.
12. Make sure that any bypass valving is left in the normal In Service position.
13. Manually index the filter to the In Service position and allow the mineral tank to fill by slowly opening the main water supply valve. Any bypass should be in the In Service position.

WATER CONDITIONER FLOW DIAGRAMS

Service Position

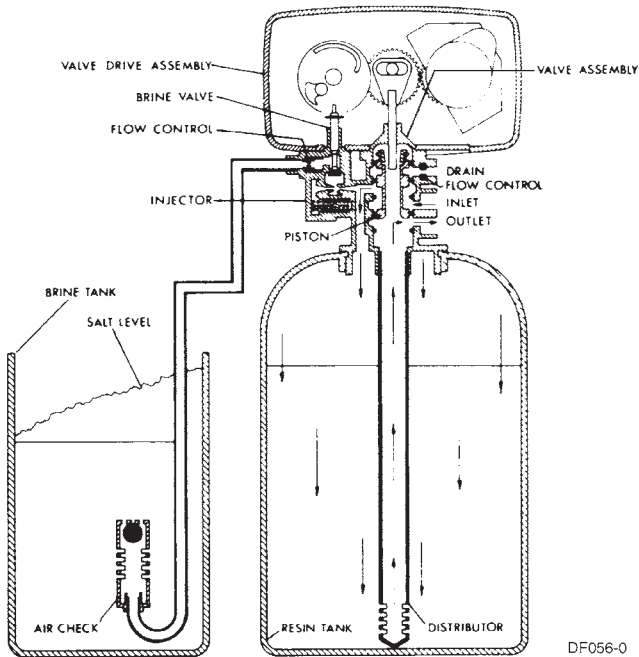

Backwash Position

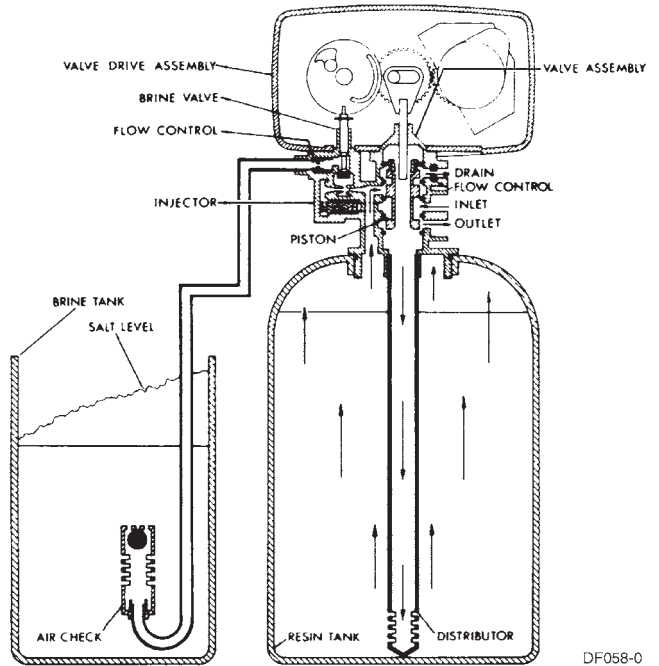

Preliminary Rinse Position

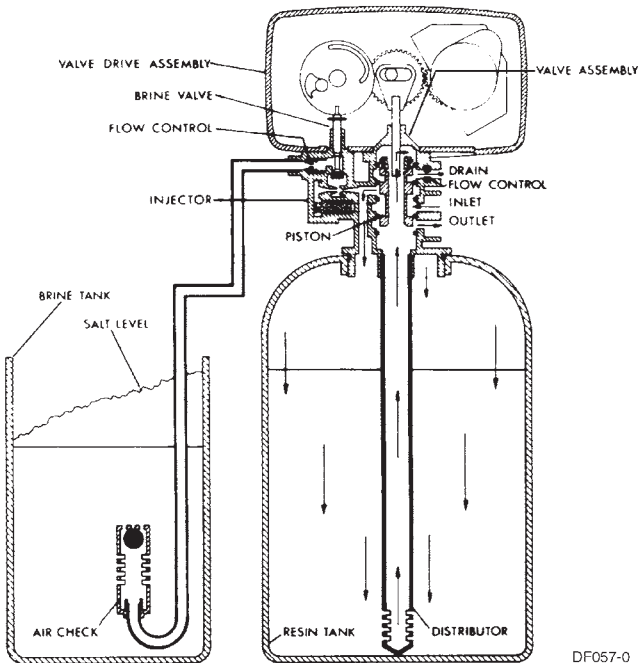

Brine Position

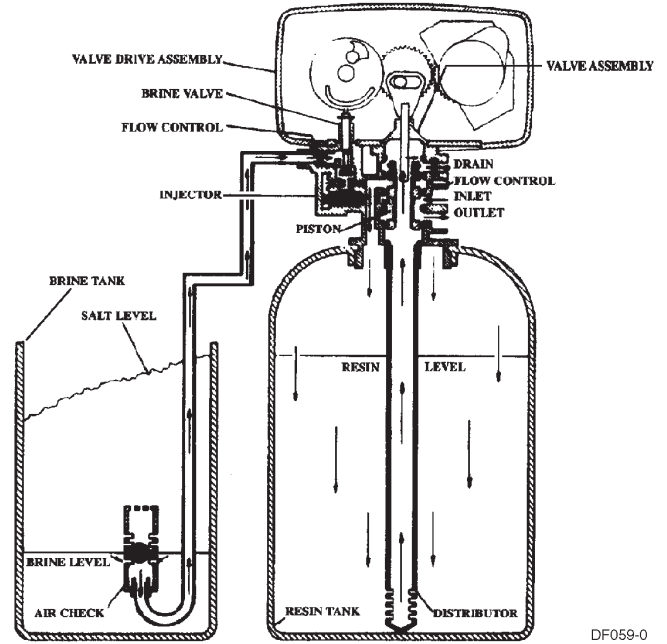

WATER CONDITIONER FLOW DIAGRAMS *CONTINUED*

Slow Rinse Position

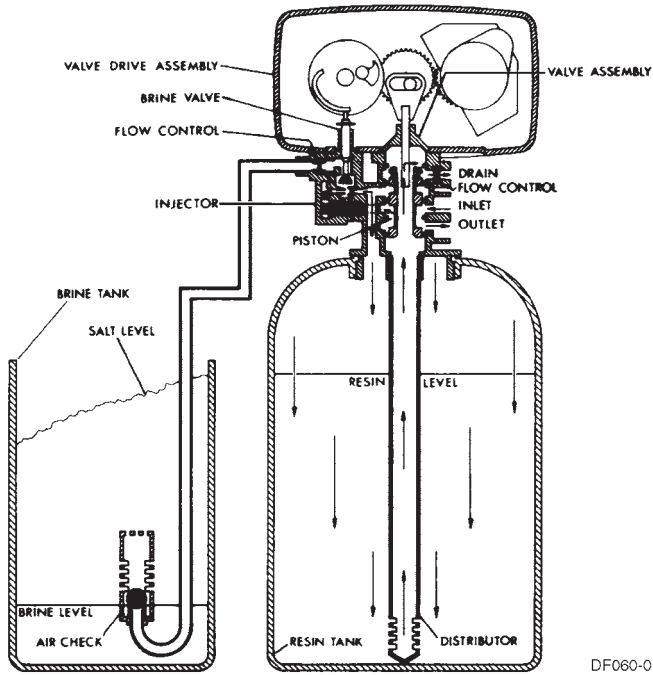

Settling Rinse Position

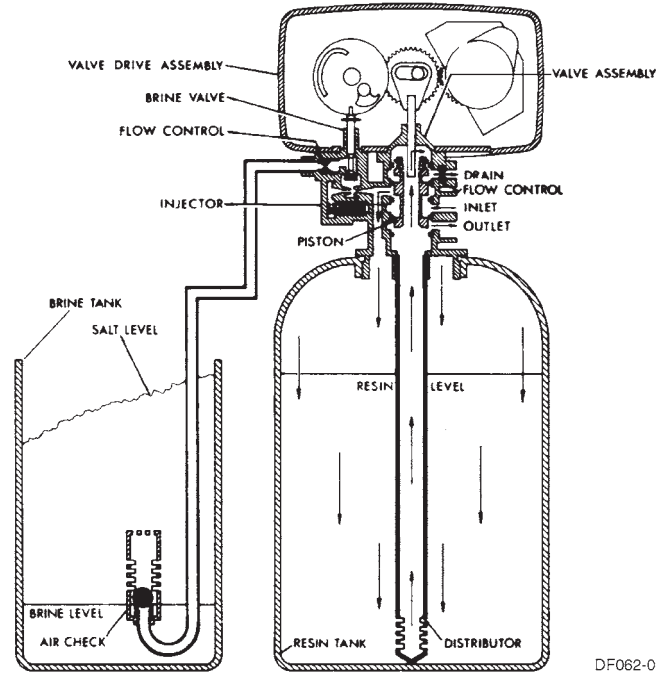

Second Backwash Position

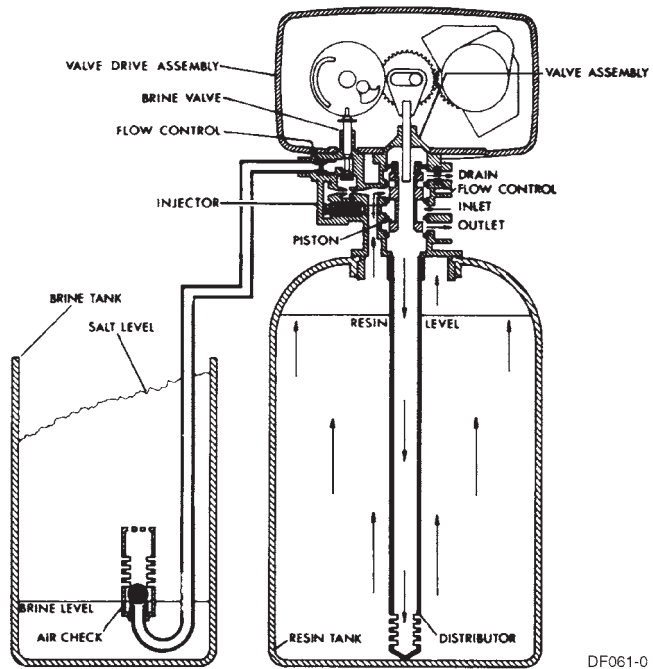

Brine Tank Fill Position

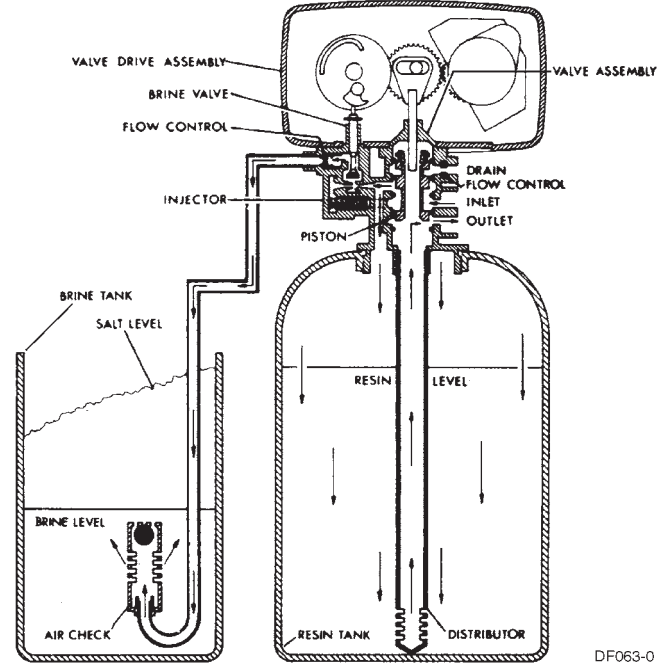

[THIS PAGE LEFT INTENTIONALLY BLANK]

MODEL 5600 CONTROL VALVE DRIVE ASSEMBLY

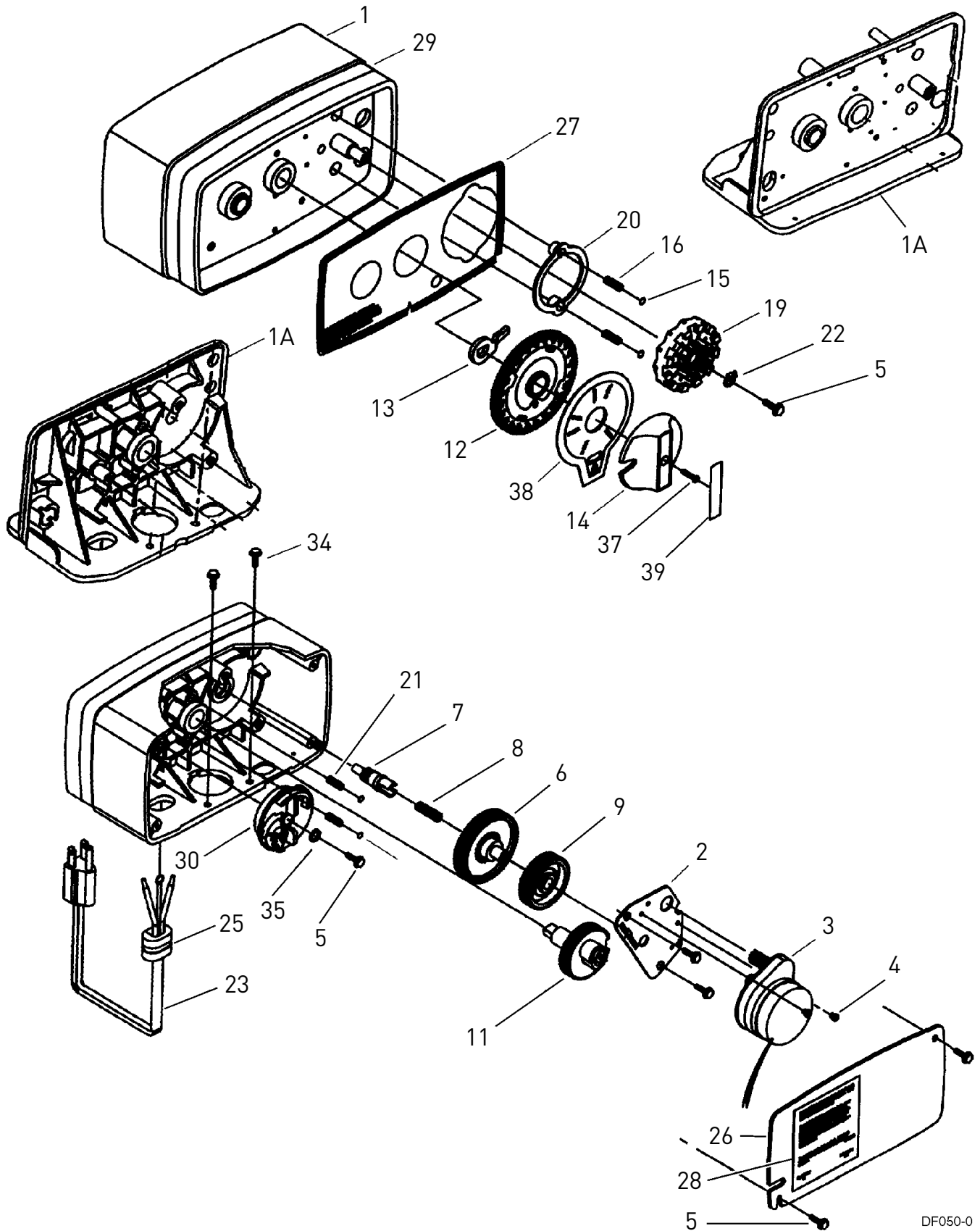

DF050-0

MODEL 5600 CONTROL VALVE DRIVE ASSEMBLY *CONTINUED*

Item No.	QTY	Part No.	Description	Item No.	QTY	Part No.	Description
1	1	14448-001	Drive Housing, with Pin Drilled for Cover	34	2	12473	Screw-drive Mounting
1A	1	15494-01	"L" Housing, with Pin	35s	1	12037	Washer
	1	15494-03	"L" Housing, with Pin Drilled for Designer	37	1	15151	Screw, Knob
2	1	13175	Motor Mounting Plate	38	1	14176	Valve Position Dial, Standard
3	1	18743	Motor, 120V, 60 Hz		1	14278	Valve Position Dial, Low Water
	1	19659	Motor, 24V, 60 Hz		1	15478	Valve Position Dial, Chemical Filter
4	(2-3)	11384	Screw, Motor Mtg. and Ground Wire		1	16715	Valve Position Dial, Filter
5	(3-5)	13296	Screw, Component Mounting	39	1	14175	Knob Label, Beige
6	1	13017	Idler Gear		1	14207	Knob Label, Silver
7	1	13018	Idler Pinion	40s	1	40214	Screw, Brine Cam
8	1	13312	Spring, Idler	s = Not use when a filter valve			
9	1	13164	Drive Gear				
11	1	13170	Main Gear and Shaft				
12	1	19205	24-hour Gear Assembly, Silver				
	1	19205-01	24-hour Gear Assembly, Tan				
13	1	13011	Cycle Actuator Gear				
14	1	14177	Knob, Manual Regeneration				
15	4	13300	Ball, 1/4" Dia.				
16	2	13311	Spring, Detent, Skipper Wheel				
19	1	14381	Skipper Wheel Assembly, 12-day				
	1	14860	Skipper Wheel Assembly, 7-day				
20	1	13864	Skipper Wheel Ring				
21	2	19080	Spring, Compression, 6700				
22	1	13014	Regeneration Pointer				
23	1	11842	Electrical Cord, Standard				
24	2	12681	Wire Connector (not shown)				
25	1	13547	Strain Relief				
26	1	13229	Back Cover				
27	1	13309	Front Label, Brown on Beige				
	1	13437	Front Label, Blue/Silver on Black				
28	1	13310	Rear Label, Softener				
	1	18520	Rear Label, Filter				
29	1	13348	Tape Stripe, Brown on Beige				
	1	13436	Tape Stripe, Blue on Silver				
30s	1	60514	Brine Cam Assembly, 3-18				
	1	60514-01	Brine Cam Assembly, 6-36				
	1	60514-02	Brine Cam Assembly, Minutes				

MODEL 5600 CONTROL VALVE DRIVE ASSEMBLY

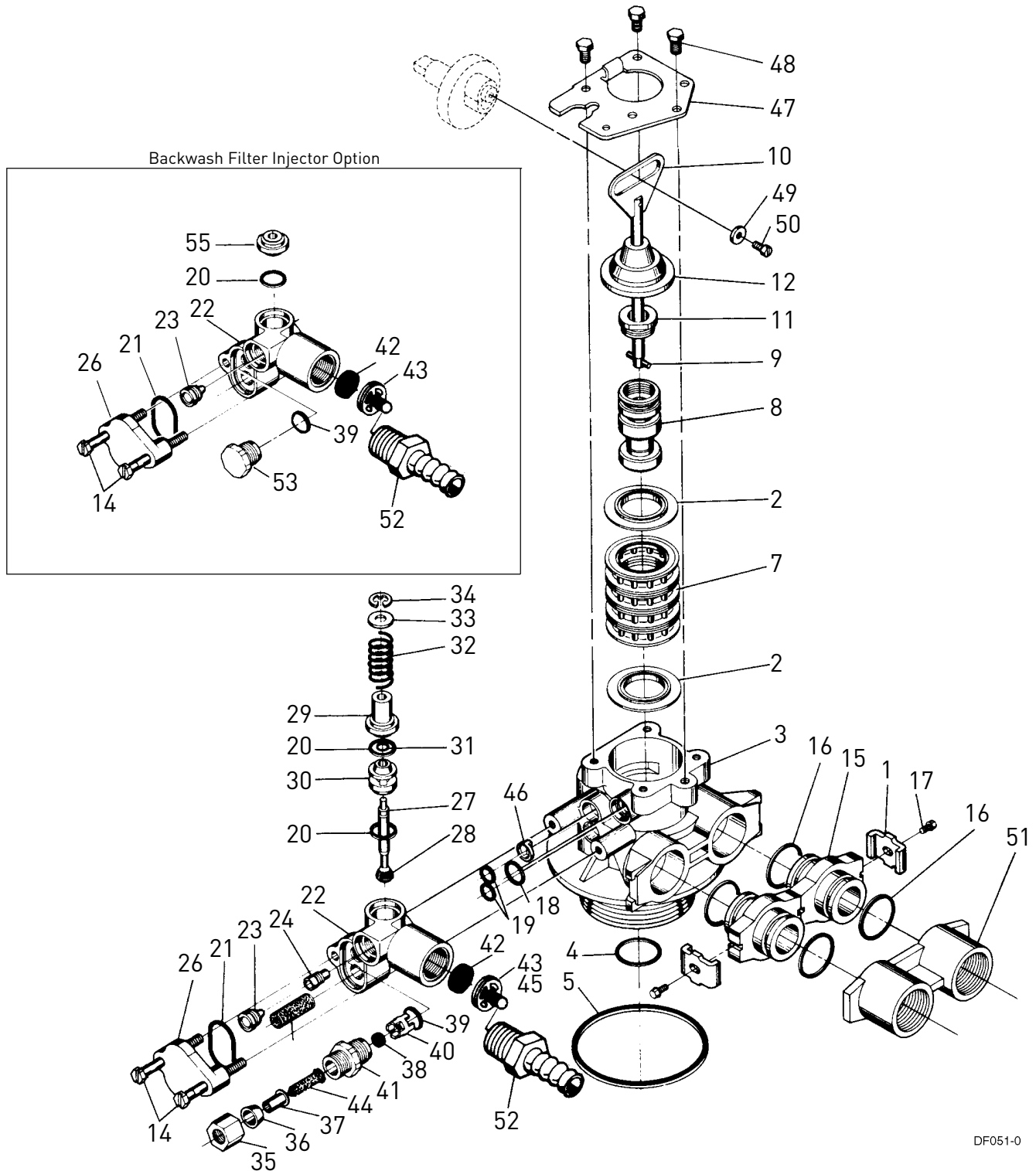

DF051-0

MODEL 5600 CONTROL VALVE DRIVE ASSEMBLY *CONTINUED*

Item No.	QTY	Part No.	Description	Item No.	QTY	Part No.	Description
1	2-4	13255	Adapter Clip (Clock or Meter)	37	1	10332	BLFC Tube Insert
2	5	13242	Seal	38	1	12094	BLFC Button, .25 gpm
	5	17772	Silicone Seal		1	12095	BLFC Button, .50 gpm
3	1	61400-12	Valve Body Assembly, 1" Dist.		1	12097	BLFC Button, 1.0 gpm
	1	61400-11	Valve Body Assembly, 3/4" Dist.	39s	1	12977	O-ring, BLFC
4	1	13304	O-ring, Distributor Tube, 1"	40	1	13245	BLFC Button Retainer
	1	10244	O-ring, Distributor Tube, 13/16"	41	1	13244	BLFC Fitting, 3/8"
5	1	12281	O-ring, Top of Tank	42	1	00000	DLFC Button, Specify Size
7	4	14241	Spacer	43	1	13173	DLFC Button Retainer
8	1	13247	Piston, Standard	44	1	12767	Screen, Brine Line
	1	13781	Piston, Low Water	45	1	15348	O-ring, DLFC (not shown)
	1	13852	Piston, Filter	46	1	13497	Air Dispenser
9	1	10696	Piston Pin	47	1	13546	End Plug Retainer
10	1	13001	Piston Rod Assembly	48	3	12112	Screw
11	1	12953	Piston Retainer	49	1	13363	Washer
12	1	13446	End Plug Assembly Standard, White	50	1	13296	Screw
	1	13446-10	End Plug Assembly Filter, Black	51A	1	13398	Yoke, Brass, 1" NPT
13	1	13446-20	End Plug Assembly Low Water, Gray		1	13708	Yoke, Brass, 3/4" NPT
14	2	13315	Screw, Injector Mounting	51B	1	18706	Yoke, Plastic, 1" NPT
15	2	19228	Adapter Coupling		1	18706-02	Yoke, Plastic 3/4" NPT
16*	4	13305	O-ring, Adapter Coupling	52	1	13308	Drain Hose Barb
17*	2-4	13314	Screw, Adapter Coupling (Clock or Meter)	53	1	13918	BLFC, Plug
18	1	12638	O-ring, Drain	54s	1	13857	Brine Valve, Plug
19	2	13301	O-ring, Injector				
20s	2	13302	O-ring, Brine Spacer				
21	1	13303	O-ring, Injector Cover				
22	1	13163	Injector Body				
23s	1	10913U	Injector Nozzle, Undrilled				
24	1	10914	Injector Throat, Specify Size				
25	1	10227	Injector Screen				
26	1	13166	Injector Cover				
27	1	13172	Brine Valve Stem				
28	1	12626	Brine Valve Seat				
29	1	13165	Brine Valve Cap				
30	1	13167	Brine Valve Spacer				
31	1	12550	Quad Ring				
32	1	11973	Spring, Brine Valve				
33	1	16098	Washer, Brine Valve				
34	1	11981-01	Retaining Ring				
35	1	10329	BLFC Fitting Nut				
36	1	10330	BLFC Ferrule				

*not used with meter controls

s = used in backwash filter

MODEL 5600 CONTROL VALVE DRIVE ASSEMBLY

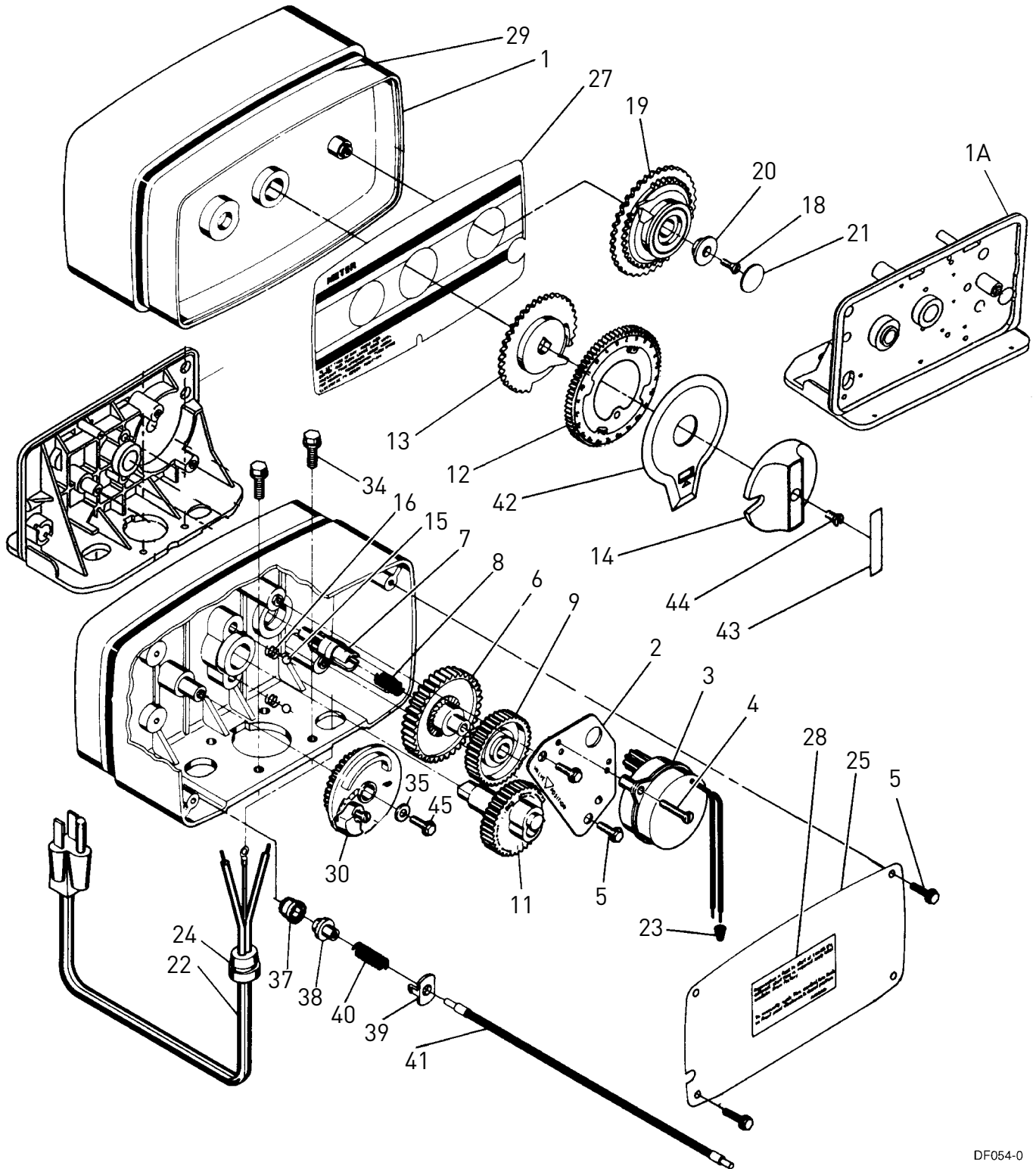

DF054-0

MODEL 5600 CONTROL VALVE DRIVE ASSEMBLY *CONTINUED*

Item No.	QTY	Part No.	Description	Item No.	QTY	Part No.	Description
1	1	14488-001	Drive Housing, with Pin Drilled for Cover	40	1	14276	Spring
1A	1	15494-01	"L" Housing, with Pin	41	1	14043	Cable Assembly, Standard
	1	15494-03	"L" Housing, with Pin Drilled for Designer		1	14910	Cable Assembly, Extended, Right Angle
2	1	13175	Motor Mounting Plate	42	1	14176	Valve Position Dial, Standard
3	1	18743	Motor, 120V, 60 Hz		1	14278	Valve Position Dial, Low Water
	1	13494	Motor, 24V, 60 Hz		1	15478	Valve Position Dial, Filter
4	2-3	11384	Screw, Motor Mtg. and Ground Wire	43	1	14175	Knob Label, Beige
5	2-4	13296	Screw, Component Mounting		1	14207	Knob Label, Silver
6	1	13017	Idler Gear	44	1	15151	Screw, Knob
7	1	13018	Idler Pinion	45	1	40214	Screw, Brine Cam
8	1	13312	Spring, Idler				
9	1	13164	Drive Gear				
11	1	13170	Main Gear and Shaft				
12	1	19205	24-hour Gear Assembly, Silver				
	1	19205-01	24-hour Gear Assembly, Tan				
13	1	13802	Cycle Actuator Gear				
14	1	14177	Knob, Manual Regeneration				
15	2	13300	Ball, 1/4" Dia.				
16	2	19080	Spring, Compression, 6700				
18	1	13748	Screw, Program Wheel				
19	1	60405-15	Program Skipper Wheel Assembly, Specify Hardness Capacity				
20	1	13806	Program Wheel Retainer				
21	1	13953	Cover Label, Program Wheel				
22	1	11842	Electrical Cord				
23	2	12681	Wire Connector				
24	1	13547	Strain Relief				
25	1	13229	Back Cover				
27	1	13955	Front Label, Beige				
	1	13958	Front Label, Silver				
28	1	13310	Rear Label, Softener				
	1	18520	Rear Label, Filter				
29	1	13957	Tape Stripe, Beige				
	1	13960	Tape Stripe, Silver				
30	1	60514	Brine Cam Assembly, 3-18				
	1	60514-01	Brine Cam Assembly, 6-36				
	1	60514-02	Brine Cam Assembly, Minutes				
34	2	12473	Screw-drive Mounting				
35	1	12037	Washer				
37	1	13830	Drive Pinion, Program Wheel				
38	1	13831	Clutch, Drive Pinion				
39	1	14253	Spring Retainer				

5600 ELECTROMECHANICAL

Softener Time Clock

Item No.	QTY	Part No.	Description
1	1	560001-003	5600, SOF, DFN, CLK, 12DA, 12060, CW 1-- , .50, LES, NA2, 1600, SOFT
		560001-004	5600, SOF, DFN, CLK, 12DA, 24-60, CW 1-- , .25, LES, NA2, 1600, SOFT
		560001-005	5600, SOF, DFN, CLK, 12DA, 12060, CW 1-- , .50, LES, NA2, 1600, SOFT
		560001-006	5600, SOF, DFN, CLK, 12DA, 24-60, CW 1-- , .50, LES, NA2, 1600, SOFT
		560001-007	5600, SOF, DFN, CLK, 12DA, 12060, CW 1-- , .50, LES, NA2, 1600, SOFT
		560001-009	5600, SOF, DFN, CLK, 12DA, 12060, CW 1-- , .50, LES, NA2, 1600, SOFT
		560001-013	5600, SOF, DFN, CLK, 12DA, 12060, CW 1-- , .25, LES, NA2, 1600, SOFT

Filter Time Clock

Item No.	QTY	Part No.	Description
1	1	560000-001	5600, FIL, DFN, CLK, 7DAY, 12060, CW BWF, BWF, LES, NA2, BWF-, FILT
		560001-001	5600, FIL, DFN, CLK, 12DA, 12060, CW BWF, BWF, LES, NA2, BWF-, FILT
		560001-002	5600, FIL, DFN, CLK, 12DA, 12060, CW BWF, BWF, LES, NA2, BWF-, FILT
		560001-008	5600, FIL, DFN, CLK, 12DA, 22050, CW BWF, BWF, LES, NA2, BWF-, FILT
		560001-010	5600, FIL, DFN, CLK, 12DA, 12060, CW BWF, BWF, LES, NA2, BWF-, FILT
		560001-012	5600, FIL, DFN, CLK, 12DA, 12060, CW BWF, BWF, LES, NA2, BWF-, FILT

Softener Meter

Item No.	QTY	Part No.	Description
1	1	560002-001	5600, SOF, DFN, M34, MDEL, 12060, CW 1-- , .50, LES, NA2, 1600, SOFT
		560002-002	5600, SOF, DFN, M34, MDEL, 24-60, CW 1-- , .50, LES, NA2, 1600, SOFT
		560002-003	5600, SOF, DFN, M34, MDEL, 12060, CW 1-- , .50, LES, NA2, 1600, SOFT
		560002-004	5600, SOF, DFN, M34, MDEL, 24-60, CW 1-- , .50, LES, NA2, 1600, SOFT
		560002-005	5600, SOF, DFN, M34, MDEL, 12060, CW 1-- , .50, LES, NA2, 1600, SOFT
		560002-006	5600, SOF, DFN, M34, MDEL, 12060, CW 1-- , .50, LES, NA2, 1600, LWAT
		560002-007	5600, SOF, DFN, M34, MDEL, 12060, CW 1-- , .50, LES, NA2, 1600, LWAT
		560002-008	5600, SOF, DFN, M34, MDEL, 24-60, CW 1-- , .50, LES, NA2, 1600, LWAT
		560002-009	5600, SOF, DFN, M34, MDEL, 24-60, CW 1-- , .50, LES, NA2, 1600, LWAT
		560002-010	5600, SOF, DFN, M34, MDEL, 12060, CW 1-- , .50, LES, NA2, 1600, SOFT
		560002-011	5600, SOF, DFN, M34, MDEL, 12060, CW 1-- , .50, LES, NA2, 1600, SOFT

Above part numbers DO NOT include the following parts.

Cover
Bypass Assembly
Yoke Assembly
DLFC with Retainer
Flow Washers
Transformer*

See accessory page for options.
 *See ordering guide for details.

5600 VALVE ACCESSORIES

Covers

- 13753-02Cover, 5600, Black
- 42345-03Cover, 5600, Mechanical, Smoke
- 42345-04Cover, 5600, Mechanical, Transparent Blue
- 60226-11Cover, 5600, Designer I, Blk/Blk
- 60226-22Cover, 5600, Designer I, Blue/Blue

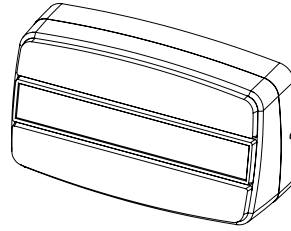

COVER

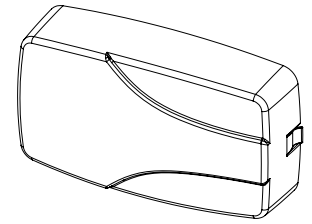

COVER, MECHANICAL

Bypasses

- 60041SS.....1" Bypass, SS, NPT
- 60040SS.....3/4" Bypass, SS, NPT
- 60049.....Bypass, Plastic

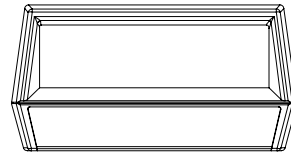

COVER, DESIGNER

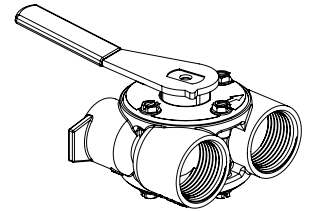

BYPASS

Yokes

- 19620-01Yoke Assy, 3/4", r/angle, 90 deg.
- 187061" Yoke, Plastic NPT
- 18706-101" Yoke, Plastic BSP
- 18706-023/4" Yoke, Plastic NPT
- 18706-123/4" Yoke, Plastic BSP
- 616941" Yoke, QC
- 617003/4" Yoke, QC
- 13708-401" Yoke, Sweat
- 41026-011" Yoke, SS, NPT
- 426903/4" Yoke, Sweat
- 41027-013/4" Yoke, SS, NPT

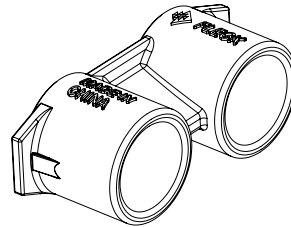

YOKE

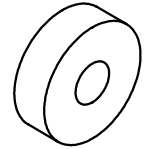

WASHER

Washers

- 19153Washer, Flow, 0.6 GPM
- 19152Washer, Flow, 0.8 GPM
- 12085Washer, Flow, 1.2 GPM
- 19150Washer, Flow, 1.3 GPM
- 12086Washer, Flow, 1.5 GPM
- 19149Washer, Flow, 1.7 GPM
- 12087Washer, Flow, 2.0 GPM
- 12088Washer, Flow, 2.4 GPM
- 12089Washer, Flow, 3.0 GPM
- 12090Washer, Flow, 3.5 GPM
- 12091Washer, Flow, 4.0 GPM
- 19147Washer, Flow, 4.5 GPM
- 12092Washer, Flow, 5.0 GPM
- 17814Washer, Flow, 6.0 GPM
- 12408Washer, Flow, 7.0 GPM

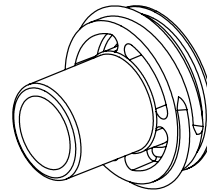

RETAINER

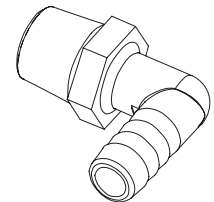

DRAIN ELBOW

Retainer

- 13173-01Retainer, DLFC Button, w/O-ring

Drain Elbows

- 123381/2" Drain Elbow, 90
- 196991/2" Drain Elbow, 45
- 131215/8" Drain Elbow, 90

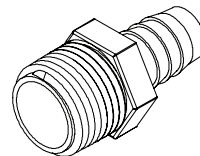

HOSE BARBS

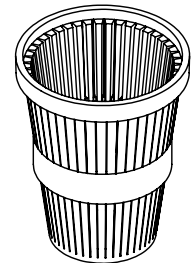

COLLECTOR

Hose Barbs

- 133081/2" Straight Hose Barb
- 13308-015/8" Straight Hose Barb

Collectors

- 18280Top Collector, 1.050
- 18280-02Top Collector, 1.050 Narrow
- 18280-01Top Collector, 1.050 Wide

5600 VALVE ASSEMBLIES

BLFC

60022-12	BLFC, 0.125 GPM (0.375 lbs NaCl/min)
60022-25	BLFC, 0.25 GPM (0.75 lbs NaCl/min)
60022-50	BLFC, 0.50 GPM (1.5 lbs NaCl/min)
60022-100	BLFC, 1.0 GPM (3 lbs NaCl/min)

Injector Drain Assemblies

60084-0001.....	Injector Drain Assy, 5600, #0, Blank DLFC, .25 BLFC
60084-0002.....	Injector Drain Assy, 5600, #0, Blank DLFC, .50 BLFC
60084-0101.....	Injector Drain Assy, 5600, #1, Blank DLFC, .25 BLFC
60084-0102.....	Injector Drain Assy, 5600, #1, Blank DLFC, .50 BLFC

Injector Assembly

60384-0	Injector Assy, Filter, 5600, Blank DLFC
---------------	---

Injector Nozzles

10913-0	Nozzle, Injector, #0, Red (8" Tank)
10913-00	Nozzle, Injector, #00, Violet (7" Tank)
10913-000	Nozzle, Injector, #000, Brown (6" Tank)
10913-1	Nozzle, Injector, #1, White (9" & 10" Tank)
10913-2	Nozzle, Injector, #2, Blue (12" Tank)
10913-3	Nozzle, Injector, #3, Yellow (13" Tank)
10913-4	Nozzle, Injector, #4, Green (14" Tank)
10913BLK.....	Nozzle, Injector, Black (Filter)

Injector Throats

10914-0	Throat, Injector, #0, Red (8" Tank)
10914-00	Throat, Injector, #00, Violet (7" Tank)
10914-000	Throat, Injector, #000, Brown (6" Tank)
10914-1	Throat, Injector, #1, White (9" & 10" Tank)
10914-2	Throat, Injector, #2, Blue (12" Tank)
10914-3	Throat, Injector, #3, Yellow (13" Tank)
10914-4	Throat, Injector, #4, Green (14" Tank)

Plugs

40947-02	Plug, Brine Valve, w/o-ring
----------------	-----------------------------

BLFC Module Plug Assembly

13918-01	BLFC Module Plug Assy, w/o-ring
----------------	---------------------------------

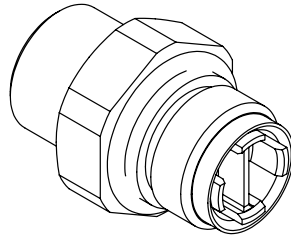

BLFC

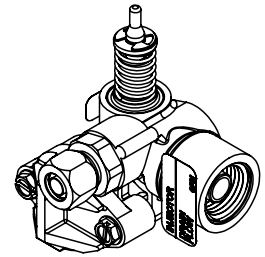

INJECTOR DRAIN ASSY

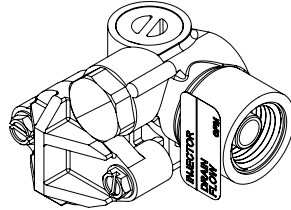

INJECTOR ASSEMBLY

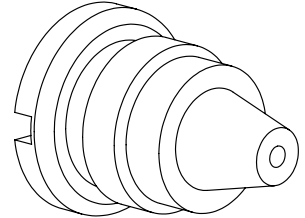

INJECTOR NOZZLE

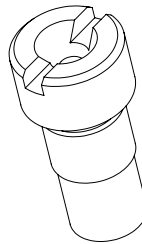

INJECTOR THROAT

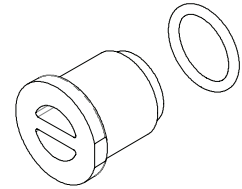

PLUG

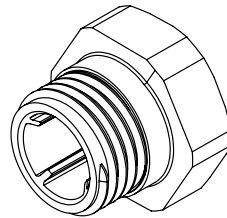

BLFC MODULE PLUG ASSY

5600 VALVE ASSEMBLIES

Labels

- 14213Label, 11.5K
- 14214Label, 13K
- 14343Label, 15K
- 14076Label, 16K
- 13969Label, 18K
- 14046Label, 21K
- 13961Label, 24K
- 14237Label, 24K, Black
- 14047Label, 26K
- 14180Label, 28K
- 13962Label, 30K
- 14048Label, 32K
- 13971Label, 36K
- 14073Label, 40K
- 14181Label, 42K
- 13974Label, 45K
- 14239Label, 48K
- 14074Label, 50K
- 14182Label, 56K
- 14034Label, 60K
- 14183Label, 70K
- 18663Label, Brine Valve Cam, 1.5-8 Lbs.
- 41124Label, Lbs. Salt, 3-16
- 41125Label, Lbs. Salt, 6-32
- 41126Label, Brine Valve Cam, Minute
- 41127Label, Brine Valve Cam, 1.5-7kg
- 41128Label, Brine Valve Cam, 3-14kg

Switches

- 60320-03Switch Assy, 5600 Auxiliary

Brine Cam Assemblies

- 60514-00Brine Cam Assy, 5600, Less Salt Label

Meters

- 60086Meter Assy, 3/4" Dual Port, Slip Std, Plas, Pdl, w/Clps
- 14043Meter Cable , 8.25"
- 60088-180Meter Assy, 3/4" Dual Port, Slip Std, Rt Ang/180, Plas, Pdl, w/clps
- 60089-180Meter Assy, 3/4" Dual Port, Slip Ext, Rt Ang/180, Plas, Pdl, w/clps
- 14910Meter Cable , 6.75"

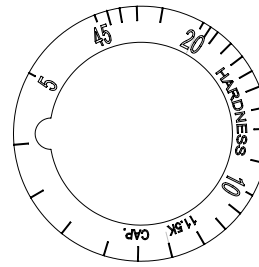

LABEL, HARDNESS

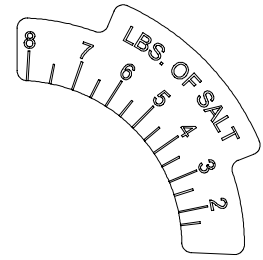

LABEL, LBS. OF SALT

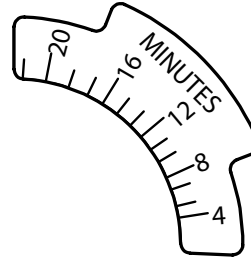

LABEL, MINUTES

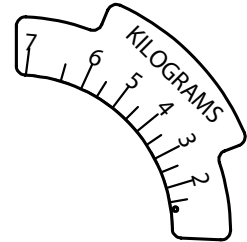

LABEL, KILOGRAMS

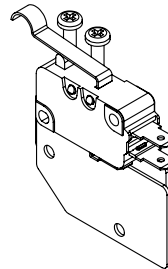

SWITCH

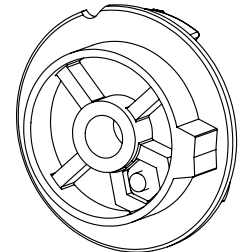

BRINE CAM ASSY

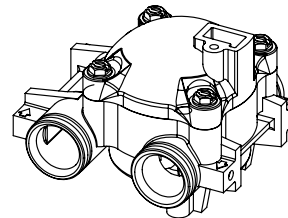

METER ASSY, PADDLE

5600 VALVE ASSEMBLIES *CONTINUED*

Powerheads

62089-01	Pwrhd, 5600, Soft, Mtr, Srng, Encl, Orange, 120/60, US Cord
62089-02	Pwrhd, 5600, Soft, Mtr, Srng, Encl, Sil/Blu, 24/60, XFMR120/24
62089-03	Pwrhd, 5600, Soft, Mtr, Srng, Encl, Sil/Blu, 120/60, US Cord
62089-04	Pwrhd, 5600, Soft, Mtr, Srng, Encl, Sil/Blu, 24/60, No Cord
62089-05	Pwrhd, 5600, Soft, Mtr, Srng, "L", Orange, 120/60, US Cord
62089-06	Pwrhd, 5600, Soft, Mtr, Srng, "L", Sil/Blk, 120/60, US Cord
62089-07	Pwrhd, 5600, Soft, Mtr, Srng, "L", Sil/Blk, 24/60, No Cord
62089-08	Pwrhd, 5600, Soft, Mtr, Xrng, "L", Sil/Blu, 120/60, US Cord
62089-09	Pwrhd, 5600, Soft, Mtr, Srng, "L", Sil/Blu, 120/60, US Cord
62089-10	Pwrhd, 5600, Soft, Mtr, Srng, "L", Sil/Blu, 24/60, No Cord
62089-11	Pwrhd, 5600, Soft, Mtr, Srng, "L", Sil/Blu, XFMR120/24, No Cord
62090-01	Pwrhd, 5600, Soft, Clk, 12D, Encl, Sil/Blu, 120/60, US Cord
62090-02	Pwrhd, 5600, Soft, Clk, 12D, Encl, Sil/Blu, 24/60, No Cord
62090-03	Pwrhd, 5600, Soft, Clk, 12D, Encl, Tan, 120/60, US Cord
62090-04	Pwrhd, 4650/5600, Soft, Clk, 12D, "L", Sil/Blk, 120/60, US Cord
62090-05	Pwrhd, 4650/5600, Soft, Clk, 12D, "L", Sil/Blk, 24/60, No Cord
62091-01	Pwrhd, 5600, Filt, Clk, 12D, Encl, Sil/Blu, 120/60, US Cord
62091-02	Pwrhd, 5600, Filt, Clk, 12D, "L", Sil/Blk, 120/60, US Cord
62091-03	Pwrhd, 5600, Filt, Clk, 35D, "L", Sil/Blk, 120/60, US Cord
62091-04	Pwrhd, 5600, Filt, Clk, 35D, "L", Sil/Blk, 24/60, No Cord
62091-05	Pwrhd, 5600, Filt, Clk, 35D, "L", Sil/Blk, 24/60, XFMR120/24

Program Wheels

60405-10	Program Wheel, w/3/4" Standard Label (0-2,100 Gallons)
60405-11	Program Wheel, Extended Metric (0 - 8 M3)
60405-15	Program Wheel, w/3/4" Standard Label w/People Label
60405-20	Program Wheel, w/3/4" Extended Label (0-10, 500 Gallons)
60405-21	Program Wheel, Extended Metric (0 - 40 M3)

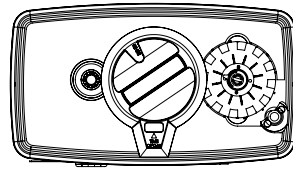

POWERHEAD

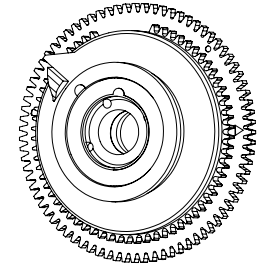

PROGRAM WHEEL

SERVICE INSTRUCTIONS

Replace Time Brine Valve, Injectors and Screen

1. Unplug electrical cord from outlet.
2. Turn off water supply to conditioner:
 - A. If the conditioner installation has a "three valve" bypass system, first open the valve in the bypass line, then close the valves at the conditioner inlet and outlet.
 - B. If the conditioner has an integral bypass valve, put it in the **Bypass** position.
 - C. If there is only a shut-off valve near the conditioner inlet, close it.
3. Relieve water pressure in the conditioner by putting the control in the **Backwash** position momentarily. Return the control to the **In Service** position.
4. Disconnect brine tube and drain line connections at the injector body.
5. Remove the two injector body mounting screws. The injector and brine module can now be removed from the control valve. Remove and discard valve body O-rings.
6. Replace brine valve.
 - A. Pull brine valve from injector body, also remove and discard O-ring at bottom of brine valve hole.
 - B. Apply silicone lubricant to new O-ring and reinstall at bottom of brine valve hole.
 - C. Apply silicone lubricant to O-ring on new valve assembly and press into brine valve hole, shoulder on bushing should be flush with injector body.
7. Replace injectors and screen.
 - A. Remove injector cap and screen, discard O-ring. Unscrew injector nozzle and throat from injector body.
 - B. Screw in new injector throat and nozzle, be sure they are seated tightly. Install a new screen.
 - C. Apply silicone lubricant to new O-ring and install around oval extension on injector cap.
8. Apply silicone lubricant to three new O-rings and install over three bosses on injector body.
9. Insert screws with washers through injector cap and injector. Place this assembly through hole in timer housing and into mating holes in the valve body. Tighten screws. (Be sure to reinstall brass spacers with injector on model **4600** valve.)
10. Reconnect brine tube and drain line.
11. Return bypass or inlet valving to normal **In Service** position. Water pressure automatically builds in the conditioner.

NOTE: Be sure to shut off any bypass line.

12. Check for leaks at all seal areas. Check drain seal with the control in the **Backwash** position.
13. Plug electrical cord into outlet.
14. Set time of day and cycle the control valve manually to assure proper function.
 - A. Make sure control valve is in the **In Service** position.
15. Make sure there is enough brine in the brine tank.
16. Rotate program wheel counterclockwise until it stops at **Regeneration** position.
17. Start regeneration cycle manually if water is hard.

Replace Timer

1. Unplug electrical cord from outlet.
 2. Turn off water supply to conditioner:
 - A. If the conditioner installation has a "three valve" bypass system, first open the valve in the bypass line, then close the valves at the conditioner inlet and outlet.
 - B. If the conditioner has an integral bypass valve, put it in the **Bypass** position.
 - C. If there is only a shut-off valve near the conditioner inlet, close it.
 3. Relieve water pressure in the conditioner by putting the control in the **Backwash** position momentarily. Return the control to the **In Service** position.
 4. Pull cable out of meter cover. Remove the control valve back cover.
 5. Remove screw and washer at drive yoke. Remove timer mounting screws. The entire timer assembly now lifts off easily.
 6. Put new timer on top of valve. Be sure drive pin on main gear engages slot in drive yoke (rotate control knob if necessary).
 7. Replace timer mounting screws. Replace screw and washer at drive yoke.
 8. Return bypass or inlet valving to normal **In Service** position. Water pressure automatically builds in the conditioner.
- NOTE: Be sure to shut off any bypass line.**
9. Plug electrical cord into outlet.
 10. Set time of day, program wheel, and salt usage. Cycle the control valve manually to assure proper function. Be sure to return the control valve to the **In Service** position.
 11. Replace the control valve back cover. Be sure grommet at cable hole is in place.
 12. Make sure there is enough brine in the brine tank.
 13. Rotate program wheel counterclockwise until it stops at **Regeneration** position.
 14. Start regeneration cycle manually if water is hard.
 15. Plug cable into meter cover, rotate cable to align drive flat if necessary.

SERVICE INSTRUCTIONS *CONTINUED*

Replace Piston Assembly

1. Unplug electrical cord from outlet.
2. Turn off water supply to conditioner:
 - A. If the conditioner installation has a "three valve" bypass system, first open the valve in the bypass line, then close the valves at the conditioner inlet and outlet.
 - B. If the conditioner has an integral bypass valve, put it in the **Bypass** position.
 - C. If there is only a shut-off valve near the conditioner inlet, close it.
3. Relieve water pressure in the conditioner by putting the control in the **Backwash** position momentarily. Return the control to the **In Service** position.
4. Pull cable out of meter cover. Remove the control valve back cover.
5. Remove screw and washer at drive yoke. Remove timer mounting screws. The entire timer assembly now lifts off easily. Remove end plug retainer plate.
6. Pull upward on end of piston yoke until assembly is out of valve.
7. Inspect the inside of the valve to make sure that all spacers and seals are in place, and that there is no foreign matter that would interfere with the valve operation.
8. Take new piston assembly as furnished and push piston into valve by means of the end plug. Twist yoke carefully in a clockwise direction to properly align it with drive gear. Replace end plug retainer plate.
9. Place timer on top of valve. Be sure drive pin on main gear engages slot in drive yoke (rotate control knob if necessary).
10. Replace timer mounting screws. Replace screw and washer at drive yoke.
11. Return bypass or inlet valving to normal **In Service** position. Water pressure automatically builds in the conditioner.

NOTE: Be sure to shut off any bypass line.

12. Plug electrical cord into outlet.
13. Set time of day, program wheel, and salt usage. Cycle the control valve manually to assure proper function. Be sure to return the control valve to the **In Service** position.
14. Replace the control valve back cover. Be sure grommet at cable hole is in place.
15. Make sure there is enough brine in the brine tank.
16. Rotate program wheel counterclockwise until it stops at **Regeneration** position.
17. Start regeneration cycle manually if water is hard.
18. Plug cable into meter cover. Rotate cable to align drive flat if necessary.

Replace Seals and Spacers

1. Unplug electrical cord from outlet.
2. Turn off water supply to conditioner.
 - A. If the conditioner installation has a "three valve" bypass system, first open the valve in the bypass line, then close the valves at the conditioner inlet and outlet.

- B. If the conditioner has an integral bypass valve, put it in the **Bypass** position.
 - C. If there is only a shut-off valve near the conditioner inlet, close it.
3. Relieve water pressure in the conditioner by putting the control in the **Backwash** position momentarily. Return the control to the **In Service** position.
 4. Pull cable out of meter cover. Remove the control valve back cover.
 5. Remove screw and washer at drive yoke. Remove timer mounting screws. The entire timer assembly now lifts off easily. Remove end plug retainer plate.
 6. Pull upward on end of piston rod yoke until assembly is out of valve. Remove and replace seals and spacers with fingers.

Replace Meter

1. Unplug electrical cord from outlet.
2. Turn off water supply to conditioner:
 - A. If the conditioner installation has a "three valve" bypass system, first open the valve in the bypass line, then close the valves at the conditioner inlet and outlet.
 - B. If the conditioner has an integral bypass valve, put it in the **Bypass** position.
 - C. If there is only a shut-off valve near the conditioner inlet, close it.
3. Relieve water pressure in the conditioner by putting the control in the **Backwash** position momentarily. Return the control to the **In Service** position.
4. Pull cable out of meter cover.
5. Remove two screws and clips at bypass valve or yoke. Pull resin tank away from plumbing connections.
6. Remove two screws and clips at control valve. Pull meter module out of control valve.
7. Apply silicone lubricant to four new O-rings and assemble to four ports on new meter module.
8. Assemble meter to control valve. Note, meter portion of module must be assembled at valve outlet.
9. Attach two clips and screws at control valve. Be sure clip legs are firmly engaged with lugs.
10. Push resin tank back to the plumbing connections and engage meter ports with bypass valve or yoke.
11. Attach two clips and screws at bypass valve or yoke. Be sure clip legs are firmly engaged with lugs.
12. Return bypass or inlet valving to normal **In Service** position. Water pressure automatically builds in the conditioner.

NOTE: Be sure to shut off any bypass line.

13. Check for leaks at all seal areas.
14. Plug electrical cord into outlet.
15. Set time of day.
 - A. Make sure control valve is in the **In Service** position.
16. Rotate program wheel counterclockwise until it stops at **Regeneration** position.
17. Start regeneration cycle manually if water is hard.
18. Plug cable into meter cover. Rotate cable to align drive flat if necessary.

SERVICE INSTRUCTIONS *CONTINUED*

Replace Meter Cover and/or Impeller

1. Unplug electrical cord from outlet.
2. Turn off water supply to conditioner:
 - A. If the conditioner installation has a "three valve" bypass system, first open the valve in the bypass line, then close the valves at the conditioner inlet and outlet.
 - B. If the conditioner has an integral bypass valve, put it in the **Bypass** position.
 - C. If there is only a shut-off valve near the conditioner inlet, close it.
3. Relieve water pressure in the conditioner by putting the control in the **Backwash** position momentarily. Return the control to the **In Service** position.
4. Pull cable out of meter cover.
5. Remove four screws on cover.
6. Lift cover off of meter module, discard o-ring.
7. Remove and inspect impeller for gear or spindle damage, replace if necessary.
8. Apply silicone lubricant to new o-ring and assemble to the smallest diameter on meter cover.
9. Assemble cover to meter module. Be sure impeller spindle enters freely into cover. Press firmly on cover and rotate if necessary to assist in assembly.
10. Replace four screws and tighten.
11. Return bypass or inlet valving to normal **In Service** position. Water pressure automatically builds in the conditioner.

NOTE: Be sure to shut off any bypass line.

12. Check for leaks at all seal areas.
13. Plug electrical cord into outlet.
14. Set time of day
 - A. Make sure valve is in the **In Service** position.
15. Rotate program wheel counterclockwise until it stops at
16. position.
17. Start regeneration cycle manually if water is hard.
18. Plug cable into meter cover. Rotate cable to align drive flat if necessary.

TROUBLESHOOTING

Problem	Cause	Correction
1. Softener fails to regenerate.	A. Electrical service to unit has been interrupted.	A. Assure permanent electrical service (check fuse, plug, pull chain or switch).
	B. Timer is defective.	B. Replace timer.
	C. Power failure.	C. Reset time of day.
2. Softener delivers hard water.	A. Bypass valve is open.	A. Close bypass valve.
	B. No salt in brine tank.	B. Add salt to brine tank and maintain salt level above water level.
	C. Injectors or screen is plugged.	C. Replace injectors and screen.
	D. Insufficient water flowing into brine tank.	D. Check brine tank fill time and clean brine line flow control if plugged.
	E. Hot water tank hardness.	E. Repeated flushings of the hot water tank is required.
	F. Leak at distributor tube.	F. Make sure distributor tube is not cracked. Check O-ring and tube pilot.
	G. Internal valve leak.	G. Replace seals and spacers and/or piston.
3. Unit uses too much salt.	A. Improper salt setting.	A. Check salt usage and salt setting.
	B. Excess water in brine tank.	B. See problem number 7.
4. Loss of water pressure.	A. Iron build-up in line to water conditioner.	A. Clean line to water conditioner.
	B. Iron build-up in water conditioner.	B. Clean control and add resin cleaner to resin bed. Increase frequency of regeneration.
	C. Inlet of control plugged due to foreign material loose from pipes by recent work done on plumbing system.	C. Remove piston and clean control.
5. Loss of resin through drain line.	A. Air in water system.	A. Assure that well system has proper air elimination control, Check for dry well condition.
6. Iron in conditioned water.	A. Fouled resin bed.	A. Check backwash, brine draw and brine tank fill, increase frequency of regeneration, increase backwash time.
7. Excessive water in brine tank.	A. Plugged drain line flow control.	A. Clean flow control.
8. Salt water in service line.	A. Plugged injector system.	A. Clean injector and replace screen.
	B. Timer not cycling.	B. Replace timer.
	C. Foreign material in brine valve.	C. Clean or replace brine valve.
	D. Foreign material in brine line flow control.	D. Clean brine line flow control.
9. Softener fails to draw brine.	A. Draw line flow control is plugged.	A. Clean drain line flow control.
	B. Injector is plugged.	B. Clean or replace injectors.
	C. Injector screen plugged.	C. Replace screen.
	D. Line pressure is too low.	D. Increase line pressure (minimum 20 psi (1.3 bar) at all times).
	E. Internal control leak.	E. Change seals, spacers and/or piston assembly.
10. Control cycles continuously.	A. Faulty timer mechanism.	A. Replace timer.
11. Drain flows continuously.	A. Foreign material in control.	A. Remove piston assembly and inspect bore, remove foreign material and check control in various regeneration positions.
	B. Internal control leak.	B. Replace seals and/or piston assembly.
	C. Control valve jammed in Brine or Backwash position.	C. Replace seals and/or piston assembly.
	D. Timer motor stopped or jammed.	D. Replace timer.

GENERAL SERVICE HINTS FOR METER CONTROL

Problem	Cause	Correction
1. Softener delivers hard water.	A. Reserve capacity has been exceeded.	A. Check salt dosage requirements and reset program wheel to provide additional reserve.
	B. Program wheel is not rotating with meter output.	B. Pull cable out of meter cover and rotate manually, program wheel must move without binding and clutch must give positive "clicks" when program wheel strikes regeneration stop (if not, replace timer).
	C. Meter is not measuring flow.	C. Check output by observing rotation of small gear on front of timer (program wheel must not be against regeneration stop for this check) each tooth to tooth is approximately 30 gallons (113.5 L) (if not, replace meter).

MODEL 5600SF TROUBLESHOOTING

Problem	Cause	Correction
1. Filter fails to backwash.	A. Electrical service to unit has been interrupted.	A. Assure permanent electrical service (check fuse, plug, pull chain or switch).
	B. Timer is defective.	B. Replace timer.
	C. Power failure.	C. Reset time of day.
2. Filter "bleeds" iron.	A. Bypass valve is open.	A. Close bypass valve.
	B. Excessive water usage.	B. Reduce days between, backwashing (see timer instructions), make sure that there is not a leaking valve in the toilet bowl or sinks.
	C. Hot water tank rusty.	C. Repeated flushings of the hot water tank is required.
	D. Leak at distributor tube.	D. Make sure distributor tube is not cracked, check O-ring and tube pilot.
	E. Defective or stripped filter medium bed.	E. Replace bed.
	F. Inadequate backwash flow rate.	F. Make sure filter has correct drain flow control, be sure flow control is not clogged or drain line restricted, be sure water pressure has not dropped, increase backwash flow rate according to specifications for your unit, see your dealer for recommendations.
3. Loss of water pressure.	A. Iron or turbidity build-up in water filter.	A. Reduce days between backwashing so filter backwashes more often, make sure filter is sized large enough to handle water usage.
	B. Inlet plugged due to foreign material broken loose from pipes by recent work done on plumbing system.	B. Remove piston and clean control.
4. Loss of filter medium through drain line.	A. Broken or missing top screen.	A. Replace top screen, must have 0.020" wide slots.
5. Drain flows continuously.	A. Foreign material in control.	A. Remove piston assembly and inspect bore, remove foreign material and check control in various cycle positions.
	B. Internal control leak.	B. Replace seals and/or piston assembly.
	C. Control valve jammed in rinse or backwash.	C. Replace piston, seals and spacers (and drive motor if necessary).

For Fleck Product Warranties visit:
Fleck para las garantías de los productos visite: } waterpurification.pentair.com
Pour Fleck garanties produit visitez le site :



WATER QUALITY SYSTEMS

5730 NORTH GLEN PARK ROAD, MILWAUKEE, WI 53209

P: 262.238.4400 | WATERPURIFICATION.PENTAIR.COM | CUSTOMER CARE: 800.279.9404 | tech-support@pentair.com

[§]For a detailed list of where Pentair trademarks are registered, please visit waterpurification.pentair.com/brands.

Pentair trademarks and logos are owned by Pentair plc or its affiliates. Third party registered and unregistered trademarks and logos are the property of their respective owners.

40106 REV K MY17 © 2017 Pentair Residential Filtration, LLC All Rights Reserved.